

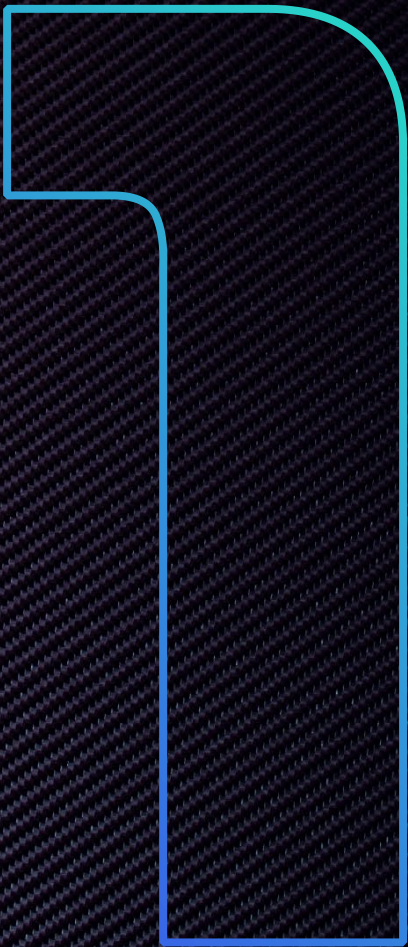

Nova TestPod User Manual

Table of Contents

INTRODUCTION	2
1.1 PURPOSE	3
1.2 QUALITY ASSURANCE	3
1.3 APPLICABILITY.....	3
EXOLAUNCH NOVA TESTPOD	4
2.1 INTRODUCTION	5
2.2 COMPONENTS AND FEATURES.....	5
TESTPOD PROPERTIES AND INTERFACES	6
3.1 PHYSICAL DIMENSIONS AND MASS PROPERTIES	7
3.1.1 MOUNTING INTERFACES	8
3.1.2 LIFTING POINTS	10
3.1.3 SLOT ADAPTERS.....	11
3.1.4 FLIGHT REPRESENTATIVENESS	11
3.2 CUBESAT INTERFACES.....	12
3.2.1 INTRODUCTION	12
3.2.2 MAXIMUM CUBESAT VOLUME.....	12
3.2.3 ACCESS WINDOWS.....	14
3.2.4 RAILS AND CLAMPING MECHANISM.....	14
3.2.5 DEPLOYMENT WAGON.....	15
3.2.6 DOOR WITH SET SCREWS.....	16
3.2.7 CHASSIS	16
3.2.8 INTEGRATION TABLE	17
3.2.9 TRANSPORTATION.....	18



Introduction

1.1 Purpose

This User Manual defines the interface requirements between a CubeSat and Exolaunch Nova TestPod which is used for mechanical testing or for fit-check purposes. The TestPod's design is based on the Exolaunch EXOpod Nova CubeSat Deployer and complies with the CubeSat Design Specification (CDS) Rev. 13.



Figure 1:
Overview of the 4U, 8U and 16U EXOpod Nova TestPods

1.2 Quality Assurance

Quality assurance for the Exolaunch TestPod is ensured at every step of production. The entire production process fulfils the highest quality assurance requirements. The facilities which manufacture Exolaunch products such as the TestPod are certified with ISO 9001:2015 standard, which requires regular inspection of the manufacturing and assembly facilities and ensures a stable quality of the final product.

1.3 Applicability

This document is applicable until it is cancelled or replaced by another issue. This User Manual is a living document open for all corrections and amendments which occur in the lifetime of the TestPod.



Exolaunch Nova TestPod

2.1 Introduction

The Exolaunch Nova TestPod has been developed to facilitate mechanical testing of CubeSats. It allows performing the full mechanical qualification of a CubeSat inside the TestPod. The TestPod can be easily mounted on a shaker table, with all mechanical interfaces being identical to the EXOpod Nova deployer used during launch. This has an additional benefit of enabling the TestPod to perform CubeSat fitchecks and also allowing a CubeSat to be shipped safely in a TestPod if required. The system offers both a combination of the highest reliability and user-friendliness.

This document describes the family of TestPods suitable for CubeSats from 1U to 16U. Chapter 4 provides a detailed description of how to operate the TestPod.

2.2 Components and Features

The main components of the 4U, 8U and 16U TestPods are shown in **Figure 2**. A detailed description is provided in Chapter 3:

- › A clamping mechanism with adjustable set screws
- › Access windows
- › A rigid chassis with different mounting interfaces
- › Slot adapters to accommodate any CubeSat size
- › Integration table for easy and safe integration

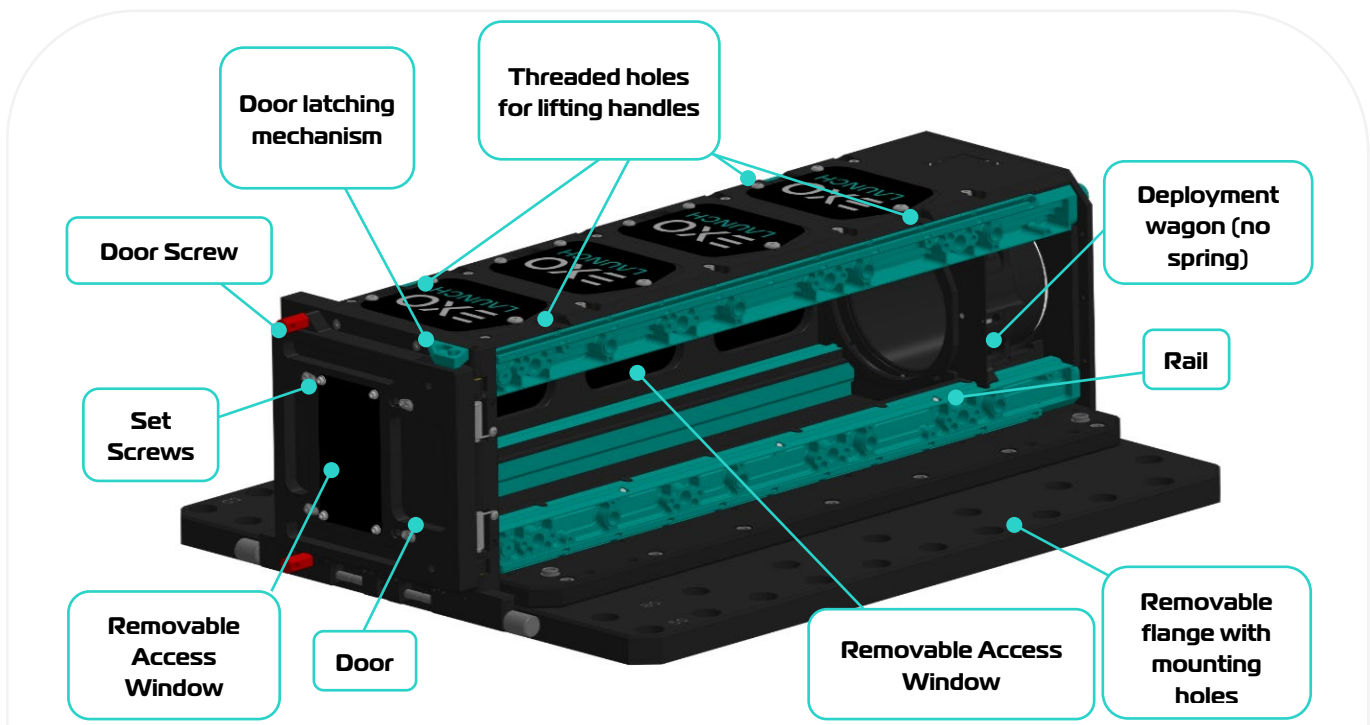

Figure 2:
Components and features of the 3U TestPod. Components are the same no matter TestPod size



TestPod Properties and Interfaces

3.1 Physical Dimensions and Mass Properties

The outer dimensions of the three different sizes of TestPods including the removable shaker adapter plate are shown in **Figure 3** to **Figure 5**.

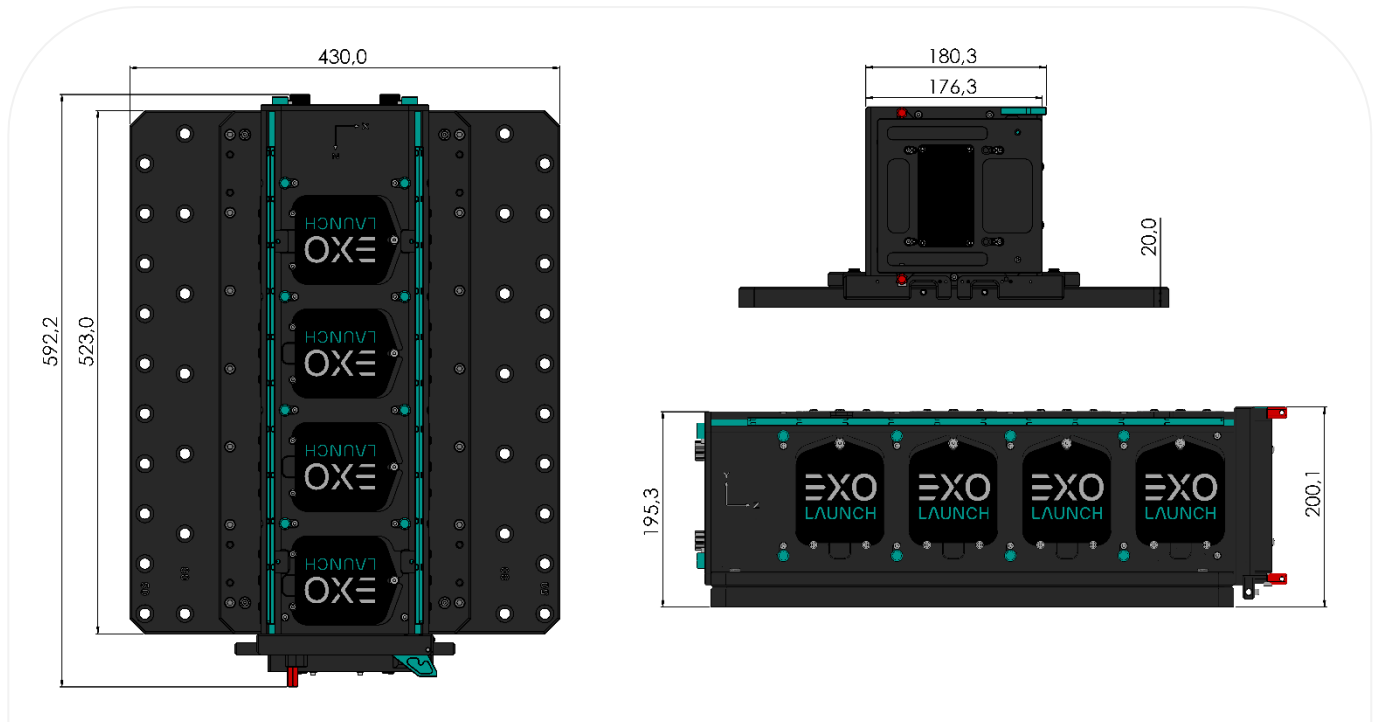

Figure 3:
Outer envelope of the 4U TestPod

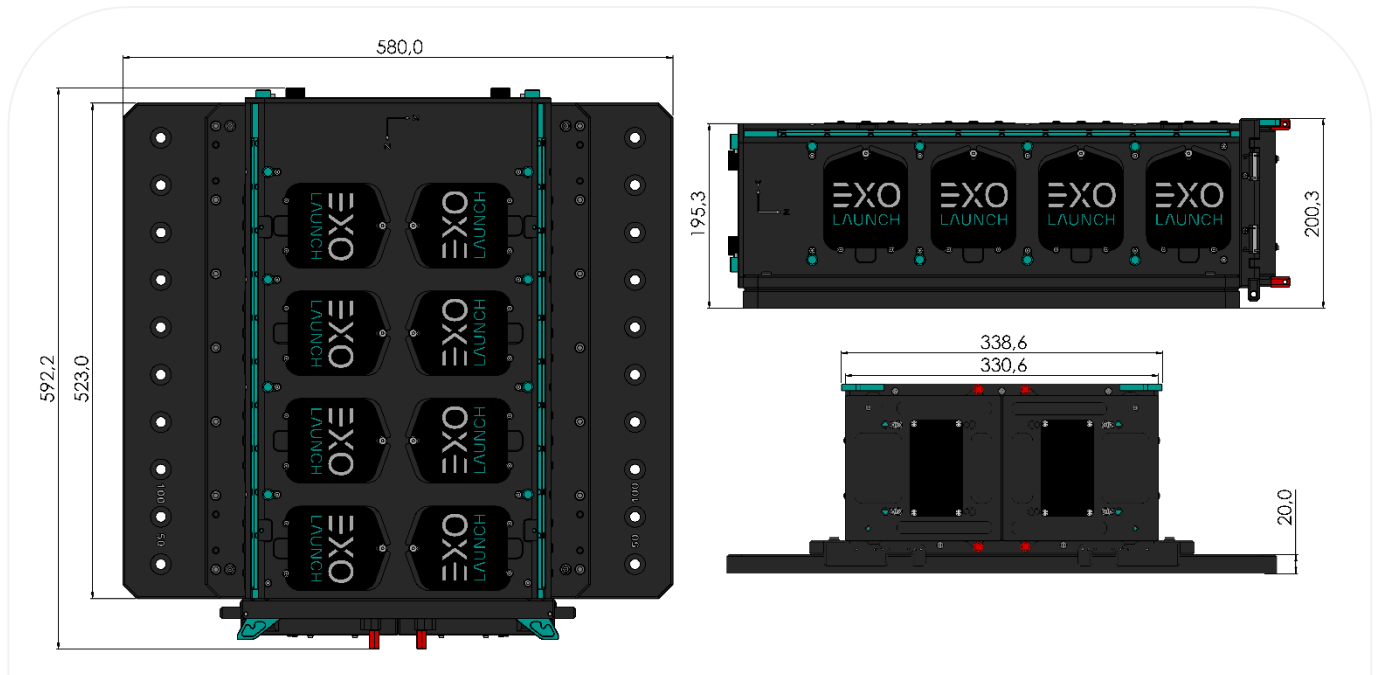

Figure 4:
Outer envelope of the 8U TestPod

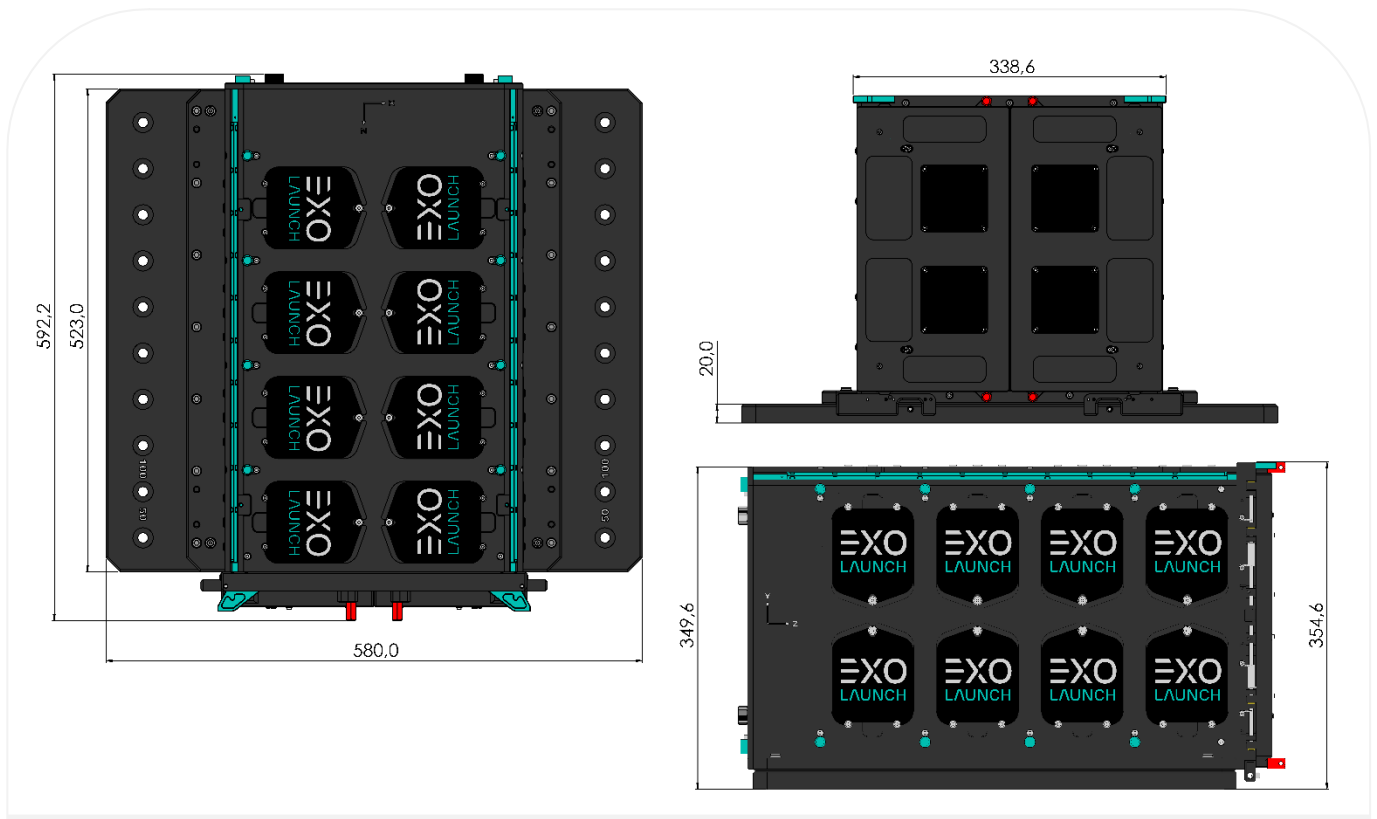

Figure 5:
Outer envelope of the 16U TestPod

The mass of the three different sizes of TestPods including the removable shaker adapter plate are shown in Table 1.

Table 1: Testpod mass with and without the shaker adapter plate

Unit	System mass [kg]	TestPod mass [kg]	Shaker adapter plate mass [kg]
Nova TestPod 4U	23.4	13.4	10
Nova TestPod 8U	34.3	20	14.3
Nova TestPod 16U	41	26.7	14.3

3.1.1 Mounting Interfaces

The 4U TestPod features two mounting hole patterns as shown in Figure 6 with the mounting hole patterns of the 8U and 16U shown in Figure 7. All the mounting holes are through-holes for M10 screws with a nominal tightening torque of **40.0 Nm**. The mounting holes have an \varnothing 18 mm, 5 mm deep counterbore for the screwhead. **Note:** A purchased TestPod can optionally be manufactured with a different hole pattern.

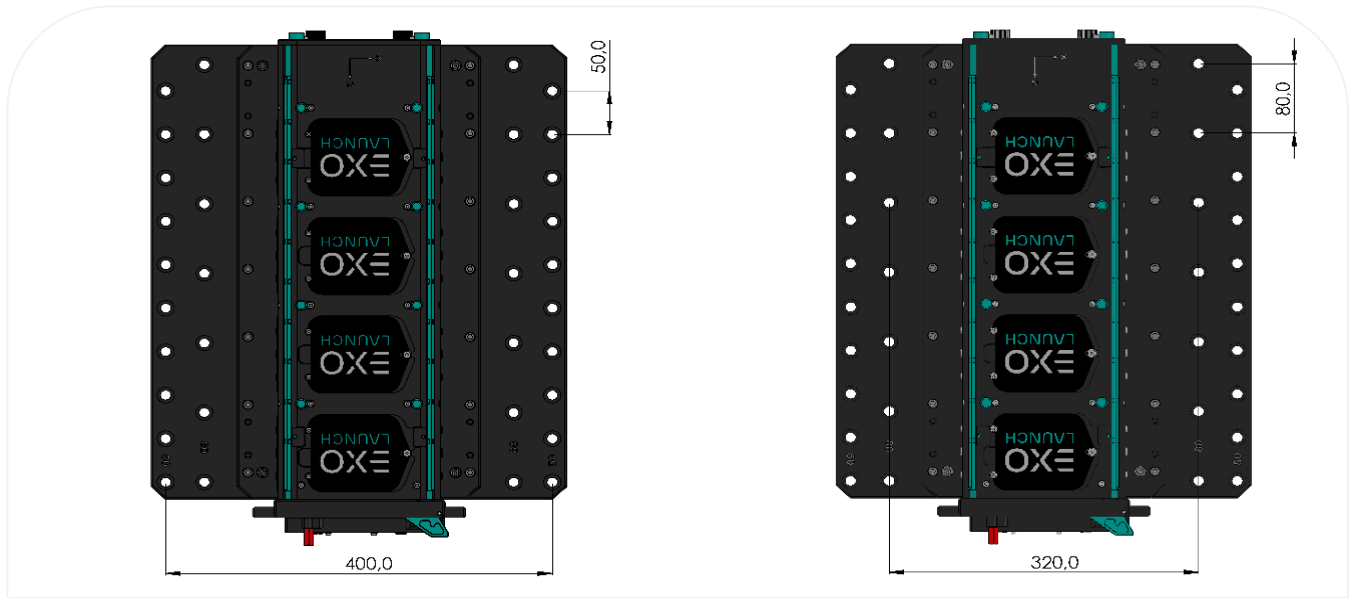

Figure 6:
Mounting interfaces of the 4U TestPod

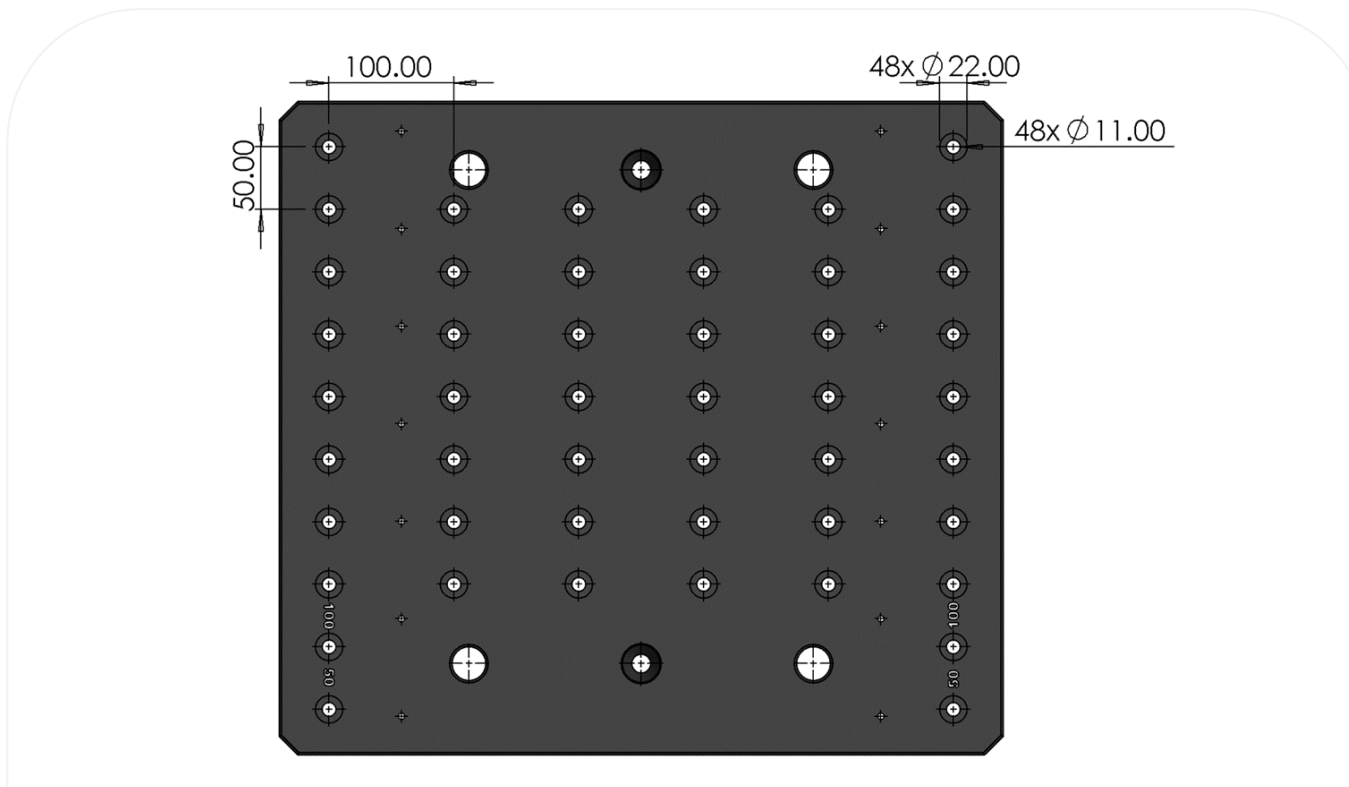

Figure 7:
Mounting interfaces of the 8U and 16U TestPod

3.1.2 Lifting Points

Every TestPod has four threaded holes on the top side which can be used to attach lifting handles. An example mounting is shown **Figure 8**. The screws are torqued to **1.0 Nm**. The handles are strong enough to carry the weight of a fully loaded TestPod with significant margin for lifting any additional masses, such as the adapter plate. For heavy lifts, the use of a crane is strongly advised.

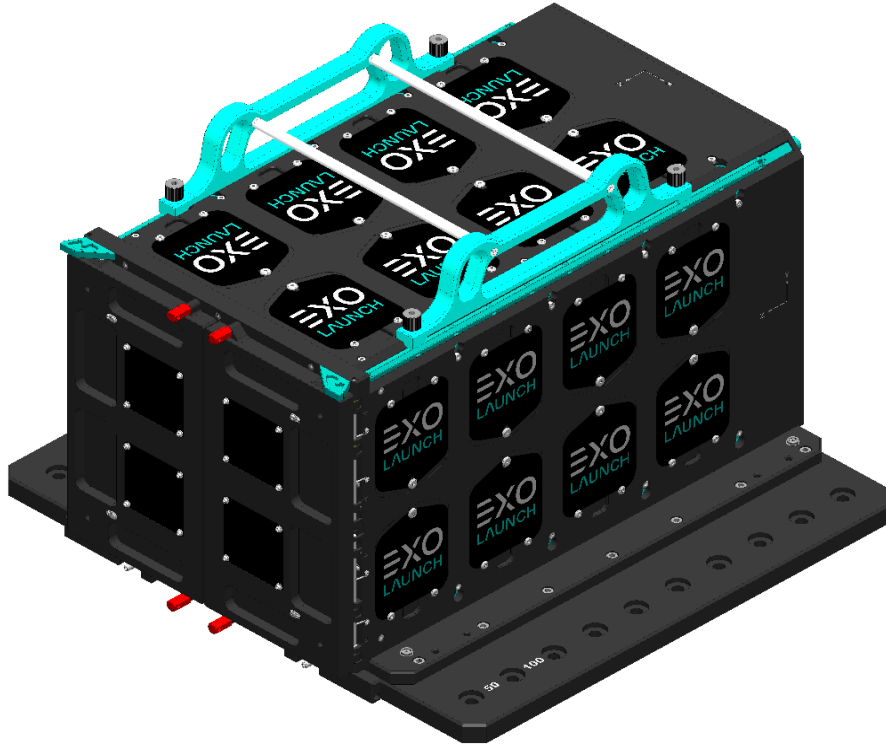

Figure 8:
Installed lifting handles with crossbars on the 16U TestPod

3.1.3 Slot Adapters

Using adapters, it is possible to fit smaller CubeSats inside a larger TestPod. For example, a 1U CubeSat or 2U CubeSat using a 3U or 2U adapter inside a 4U TestPod. These adapters are standard U sizes but can be customized if the CubeSat is uniquely sized. The adapters are inserted into the TestPod before the CubeSat is integrated.



Figure 9:
Examples of slot adapter sizes

3.1.4 Flight Representativeness

The CubeSat Design Specification does not outline requirements for flight representativeness of a TestPod or test fixture. The internal mechanical interface in the TestPod is identical to that of an EXOpod Nova deployer which allows the TestPod to be used for fitcheck purposes. The stiffness of the TestPod structure is significantly higher when compared to the EXOpod Nova deployer or any other typical deployment systems on the market. This, in combination with a different mounting interface, does have an influence on load transmissibility and levels experienced by the satellite. This difference is widely accepted by satellite manufacturers and launch providers in the scope of mechanical testing of CubeSats. Altering test levels to account for structural differences and dampening effects of the TestPod is not required. In some cases, when a more accurate representation of flight environments is deemed necessary, a test in a fully flight-like separation system may be preferable and can be performed on a case-by-case basis.

3.2 CubeSat Interfaces

3.2.1 Introduction

The Exolaunch TestPod has been developed to follow the CubeSat Design Specification (CDS). However, changes have been implemented which allow for integrating CubeSats that exceed some dimensions which are specified in the CDS, while still accommodating fully CDS-compliant CubeSats.

CubeSats are constrained by three separate elements on the deployers: the rails, the deployment wagon, and the set screws located on the doors.

3.2.2 Maximum CubeSat Volume

CubeSats in Exolaunch Nova TestPods and deployers are allowed to exceed some of the constraints in the CDS. For example, Exolaunch Nova TestPods and deployers allow features to extend between 25-40 mm from the rails depending on the size of the CubeSat.

The maximum allowable dimensions for any CubeSat size are outlined in [Figure 10](#) and [Figure 11](#) as well as [Table 2](#). The teal-colored areas (rails) mark the CubeSat interfaces with the TestPod; these dimensions must be followed for the CubeSat to fit inside the TestPod. The grey volume can be used in any desired way with the blue area representing the so-called Tuna Can.

The CDS states that Aluminum 7075, 6061, 5005 and/or 5052 shall be used for both the main CubeSat structure and the rails. However, the rails must additionally be hard anodized. No other processes or materials shall be used. Any deviation from the CDS, such as but not limited to the use of different materials or surface finishes, i.e., other forms of anodizing or a chromate conversion dual finish, may be incompatible with the Nova TestPod or deployer. Any deviation from these requirements shall be approved by Exolaunch in written form.

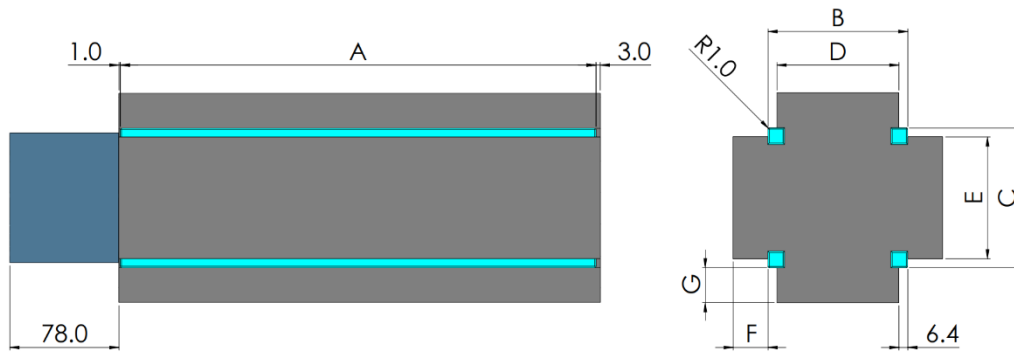

Figure 10: Maximum allowable dimensions for CubeSats launched in an EXOpod Nova or Nova TestPod. Contact areas are marked in mint green

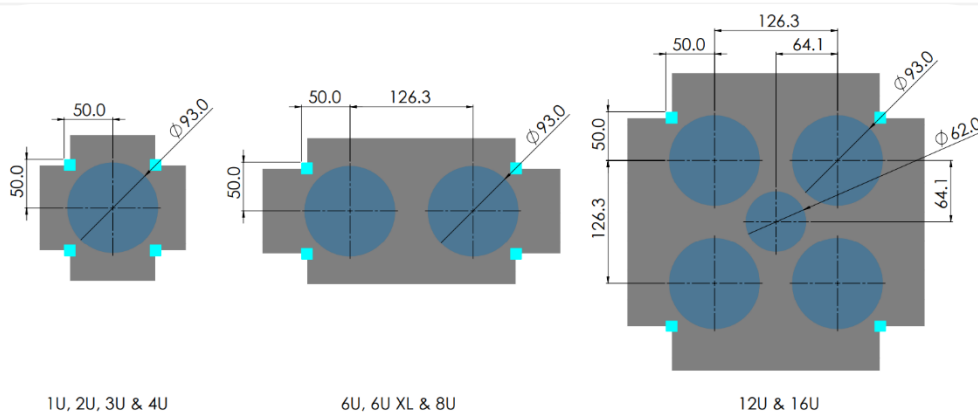

Figure 11: Maximum allowable tuna can dimensions for CubeSats launched in an EXOpod Nova or Nova TestPod

Table 2: Maximum CubeSat dimensions

Description		Units	Letter	1U, 2U, 3U, 4U	6U, 6U XL, 8U	12U	16U
CubeSat Rail Length (Z)	[±0.5 mm]	mm	A	1U: 113.5 2U: 227.0 3U: 340.5 4U: 454.0	6U: 340.5 6U XL: 365.9 8U: 454.0	340.5	454.0
CubeSat Rail Width (X)	[±0.1 mm]		B	100.0	226.3	226.3	
CubeSat Rail Height (Y)	[±0.1 mm]		C		100.0		
Max Space Between Rails (X)			D		213.5	213.5	
Max Space Between Rails (Y)			E	87.2	87.2		
Max Protrusion from Rail (X)			F		39.5	39.5	
Max Protrusion from Rail (Y)			G	25.0	25.0		
Number of Tuna Cans			-	-	1	2	4*
Distance Between Tuna Cans		mm	-	-	126.3		
Maximum Mass		kg	-	8	16	32	36

*The 12U and 16U S1 Nova has an additional, fifth tuna can be located in the center between the four larger tuna cans, see . The depth usable depth of this tuna can is 67 mm with a 62 mm diameter.

3.2.3 Access Windows

The access windows are located on the three outer faces of the TestPod allowing for easy and quick access to the satellite after integration for attachment of the accelerometers, visual inspection or for a quick functional test using external ports during any point of the testing campaign. The exact dimensions and location of the windows is shown in **Figure 12**. The nominal torque for the access windows is 1 Nm.

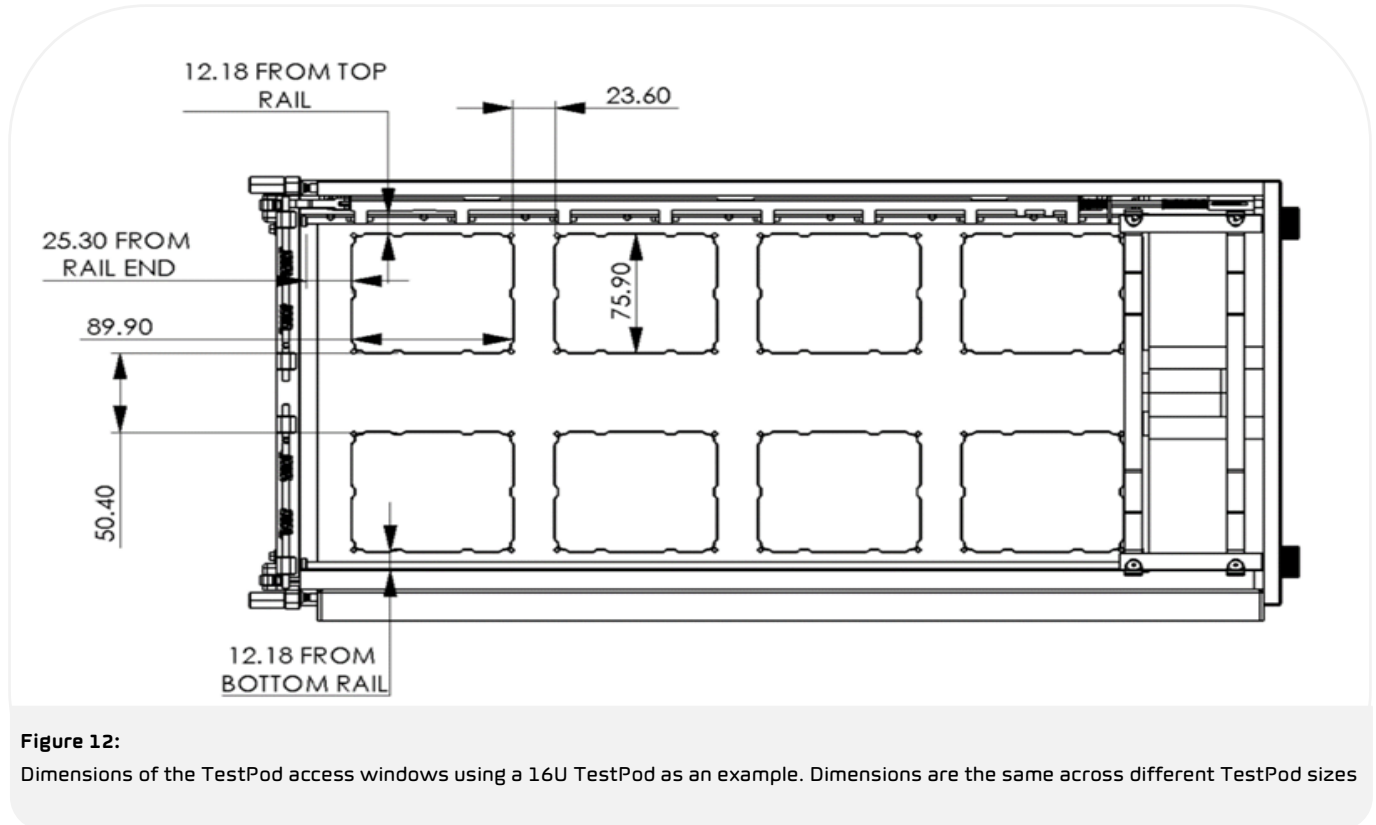

Figure 12:

Dimensions of the TestPod access windows using a 16U TestPod as an example. Dimensions are the same across different TestPod sizes

3.2.4 Rails and Clamping Mechanism

The CubeSat rails are the primary interface between the satellite and TestPod. The Nova TestPod uses the same clamping system as the EXOpod Nova. Exolaunch has developed a unique clamping system which is highly effective at constraining the satellite in the X and Y directions, thereby preventing it from shaking and rattling during transportation and launch. This clamping force is achieved by moving clamping surfaces on up to three guidance rails inwards towards the CubeSat. The mechanism engages as the door is closed, and the force increases linearly with a decreasing opening angle of the door.

The total clamping force of the mechanism varies depending on the size of the slot as well as on the size of the CubeSat within the allowable tolerances. 4U, 8U and 16U slots have a clamping mechanism built into one, two and three rails respectively. The different clamping forces are illustrated in **Figure 13**. As an example, a CubeSat on the lower end of the allowable size or 99.9 mm will experience a lower clamping force than a CubeSat closer to 100.1 mm. A changing clamping force has a notable impact on the transfer function and is one of the reasons why FE-modelling of coupled systems incl. CubeSat, CubeSat deployers and TestPods is not advised.

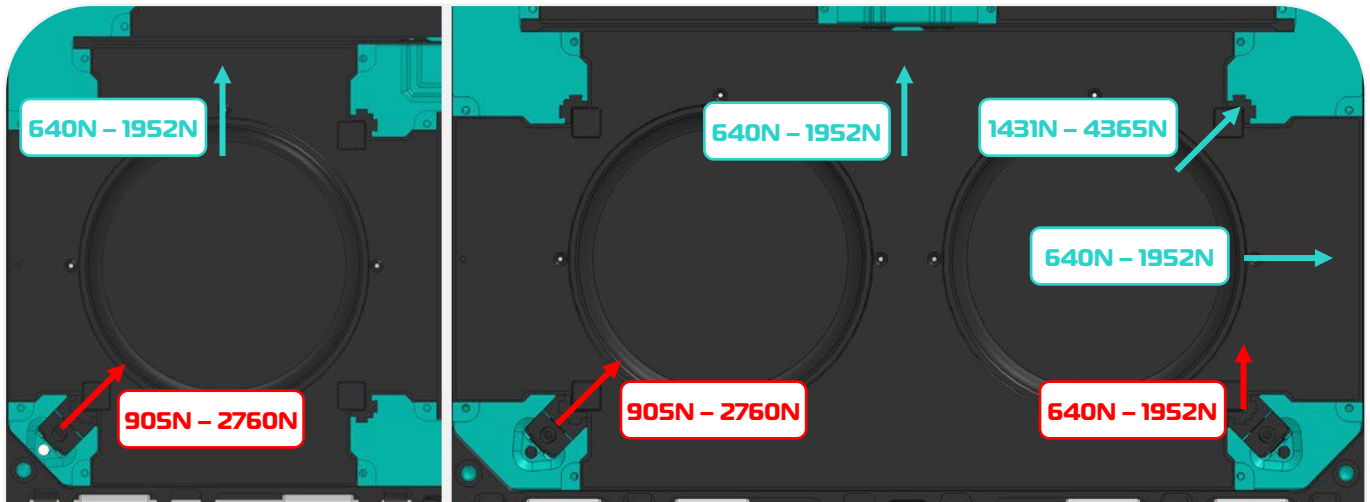

Figure 13:
Clamping forces in 4U (left) and 8U (right) CubeSat slots

3.2.5 Deployment Wagon

The deployment wagon is situated between the back wall of the TestPod and the CubeSat. In the Exolaunch Deployer it serves to keep the spring in the correct orientation and ensures that the spring force is delivered correctly to the CubeSat. In the TestPod, the deployment wagon does not carry a spring. It serves as a mechanical interface and is fixed in place using four knurled screws located on the back side of the TestPod. Nominal tightening torque for the knurled screws **1.0 Nm**. When these screws are removed, a set of pusher tools can be used to facilitate the CubeSat's de-integration. Both the deployment wagon and the pusher tools are shown below in Figure 14.

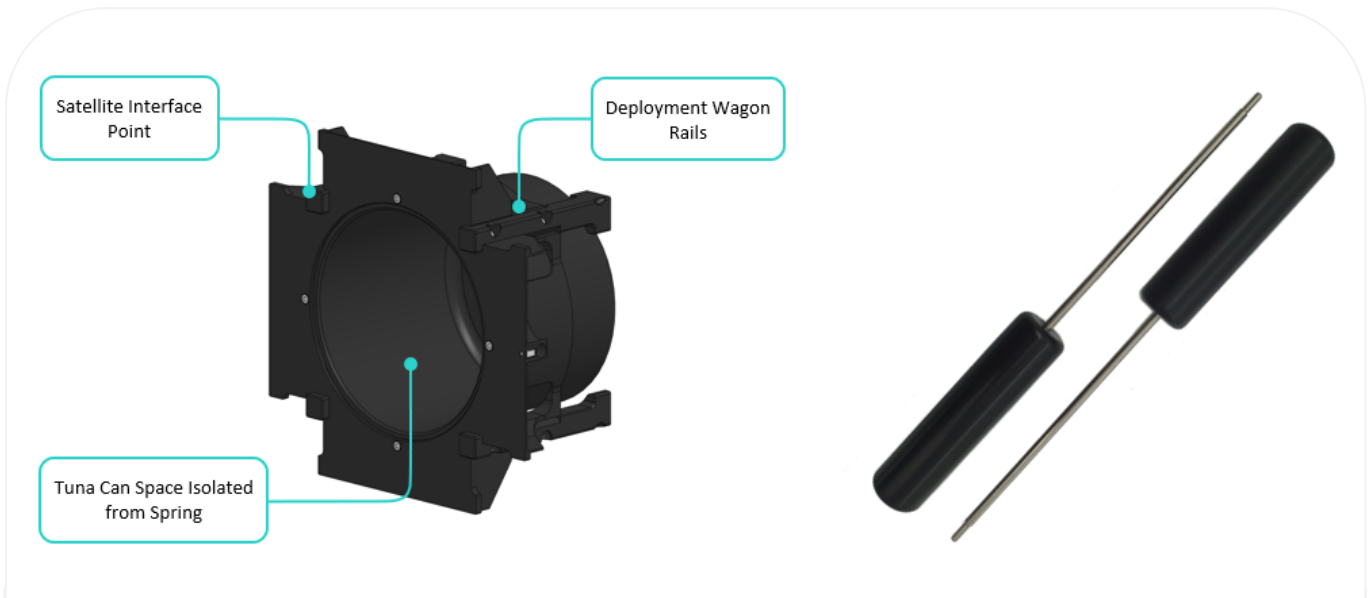
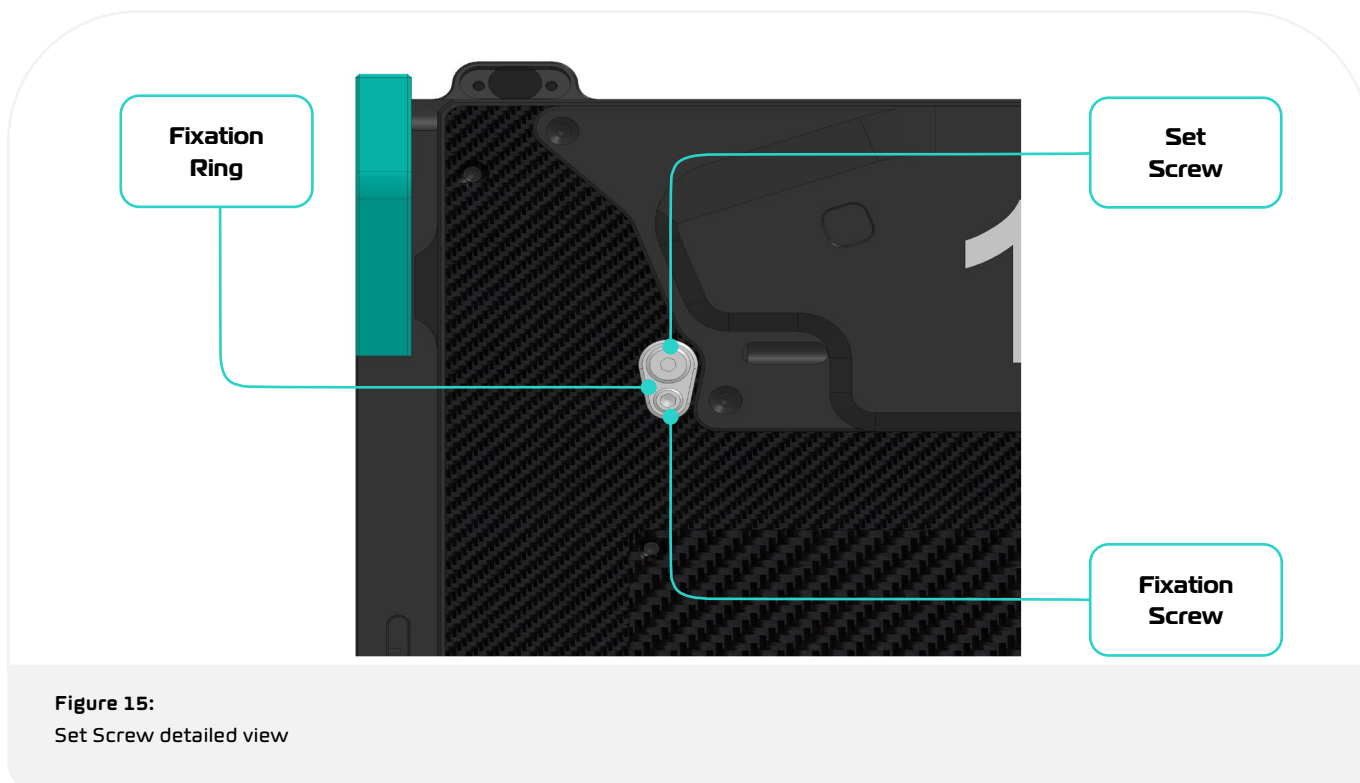

Figure 14:
Left: Deployment Wagon for the 3U TestPod.
Right: Pusher tools to facilitate de-integration of the CubeSat

3.2.6 Door with Set Screws

CubeSats are secured inside the slot by means of a clamping mechanism, which applies a clamping force in the X and Y directions. CubeSats are further constrained in the Z-direction by the combination of the Deployment Wagon and the adjustable set screws located on the slot doors (see **Figure 15**). Once a satellite is placed inside TestPod, the door is closed, and the set screws are then tightened. This eliminates any gap created by loose tolerances, thus prohibiting any movement in the deployment direction.

Each set screw is prevented from loosening by means of a fixation ring. When the fixation ring is engaged, it is deformed such that both the set screw and the fixation ring screw are both under increased running torque, thus retaining both fasteners.



3.2.7 Chassis

The TestPod is designed to be stiff and durable to maximize lifetime and reliability. This has the benefit of decoupling resonance frequencies from those of CubeSat. The removable flange allows easy mounting of the Nova TestPod on the shaker table and has up to two mounting hole patterns. For custom hole sizes and pitches, please talk to Exolaunch.

3.2.8 Integration Table

For easier integration into the TestPod, Exolaunch has developed an Integration Table, see **Figure 16**. The Integration Table rails align with the TestPod rails to sliding in the CubeSat quickly and safely. A detailed description of the integration process is provided in Section 4.

The Nova TestPod is further compatible with a similar integration table which was developed for the EXOpod Nova CubeSat deployer, allowing for safe and seamless integration from the TestPod into the Nova deployer, e.g. if the TestPod was used for shipment.

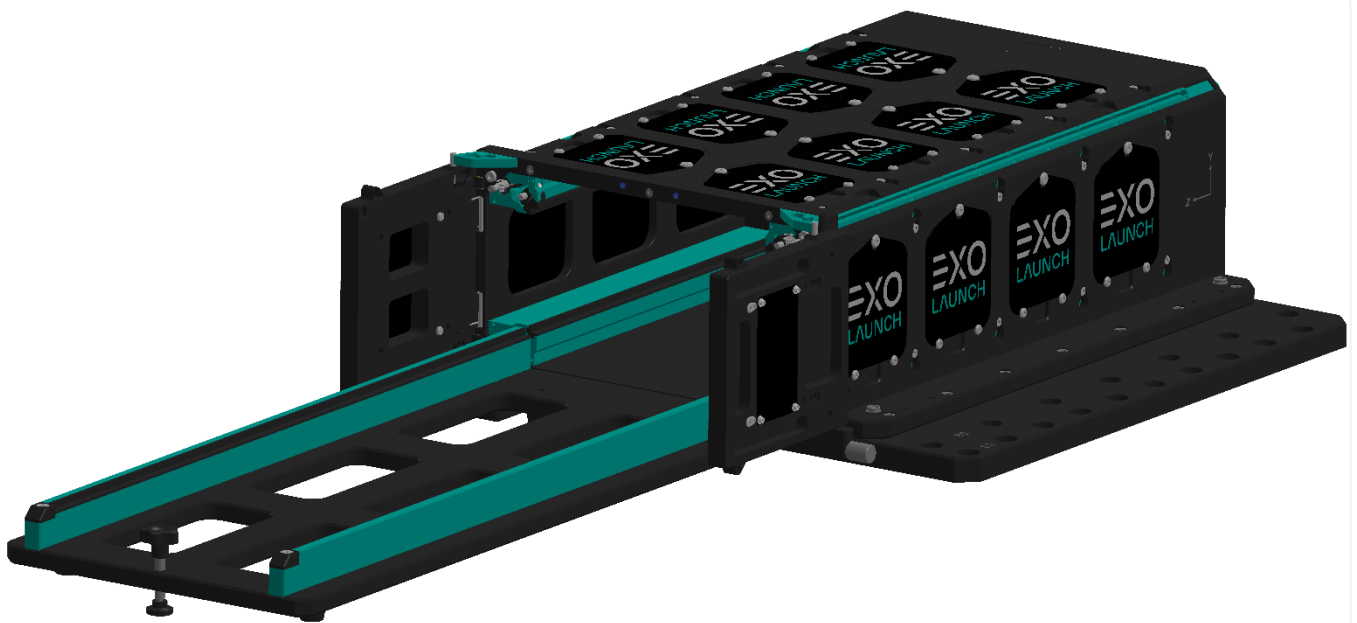

Figure 16:
Integration Table attached to the TestPod

3.2.9 Transportation

For transportation purposes, the bottom plate that attaches the TestPod to the shaker table can be removed. This improves the mobility of the TestPod and simplifies transportation.



Figure 17:
Bottom plate removed for transportation purposes

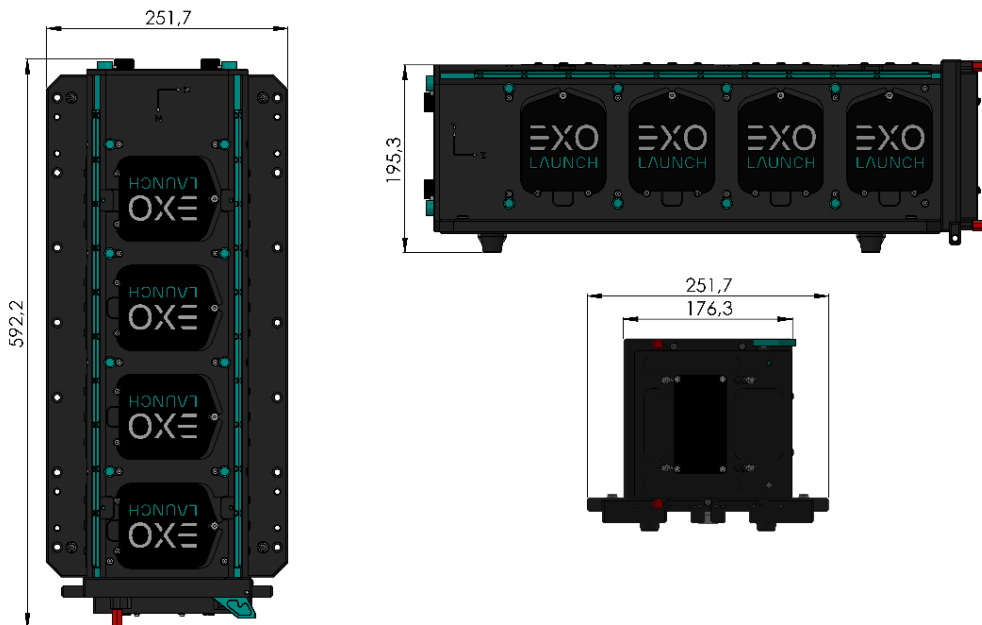

Figure 18:
Outer envelope of the 4U TestPod without the bottom plate

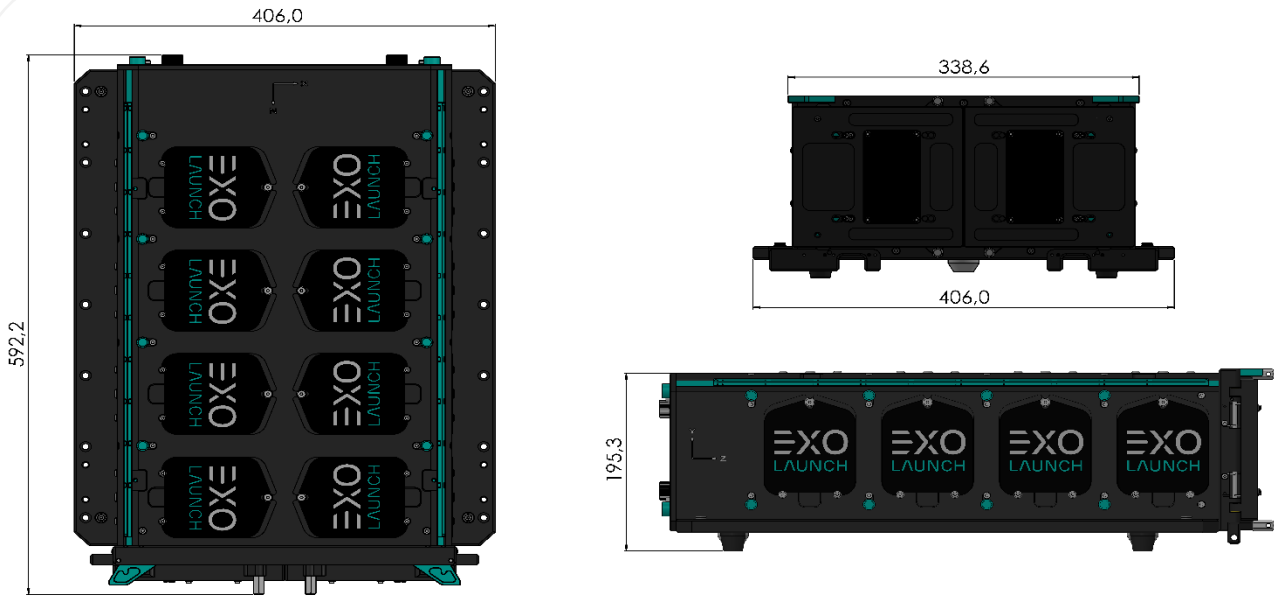

Figure 19:
Outer envelope of the 8U TestPod without the bottom plate

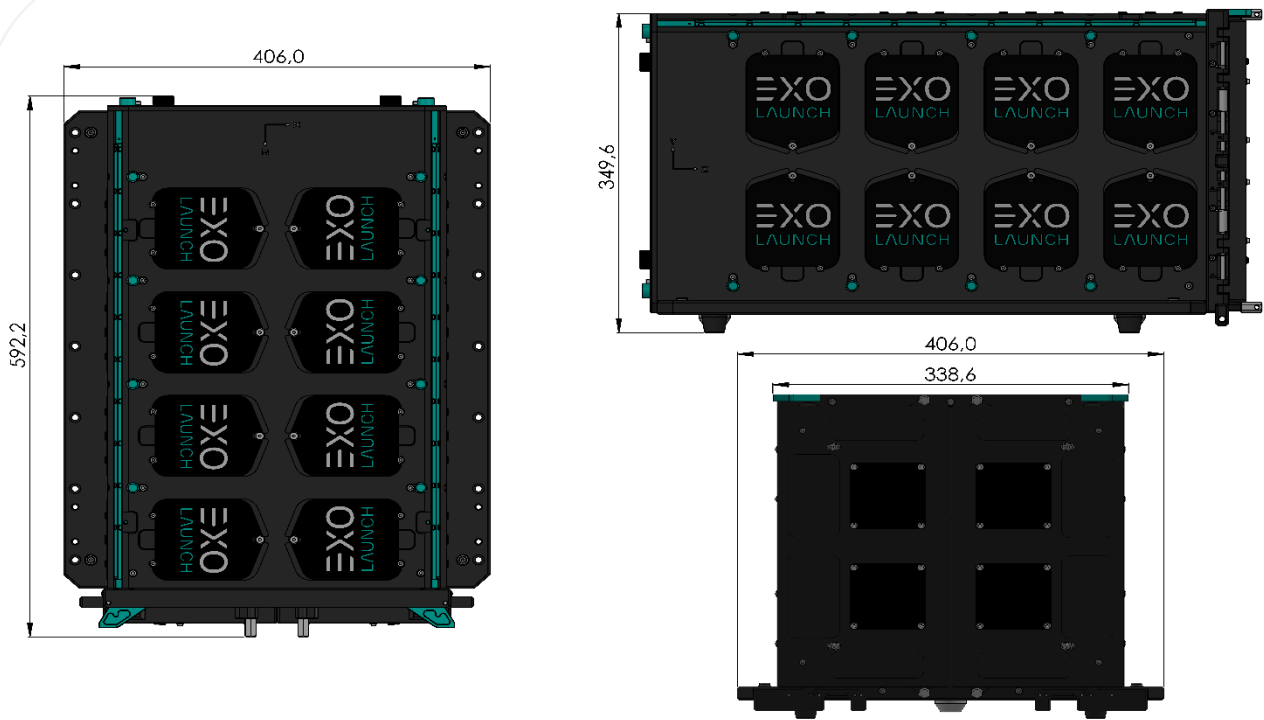

Figure 20:
Outer envelope of the 16U TestPod without the bottom plate

EXOLAUNCH

SPACE. LET US
TAKE YOU THERE

